

PROFILES FOR WINDOWS

1A

kg/m: 1,72

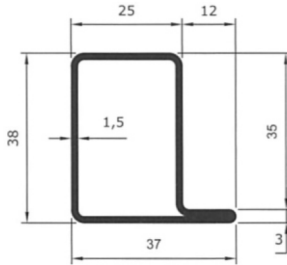

1B

kg/m: 2,1

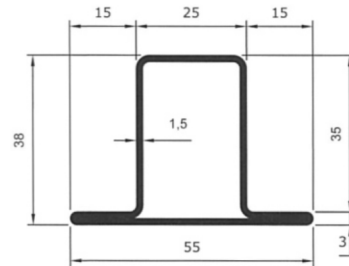

2A

kg/m: 1,76

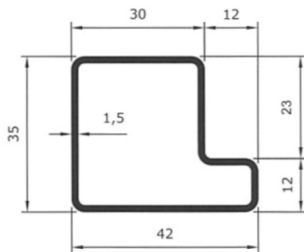

2B

kg/m: 1,88

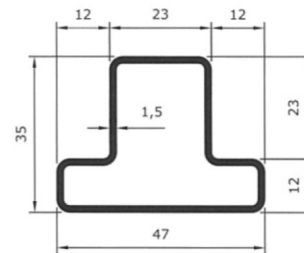

16A

kg/m: 2,33

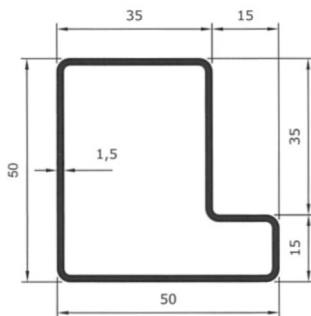

16B

kg/m: 2,33

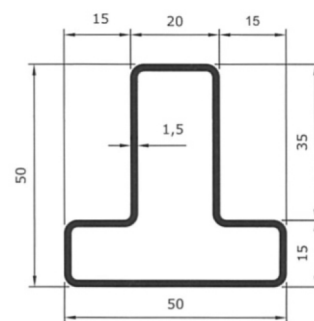

PROFILES FOR WINDOWS

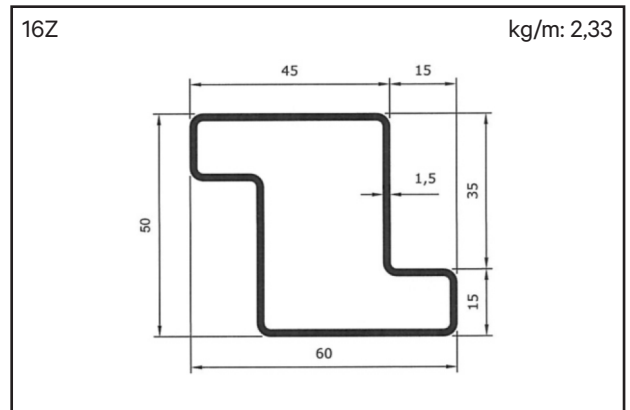
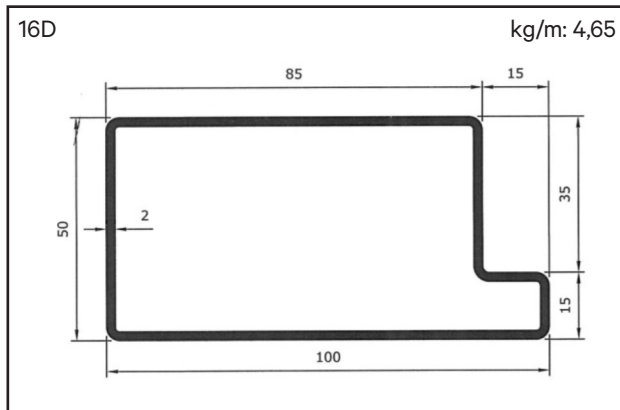
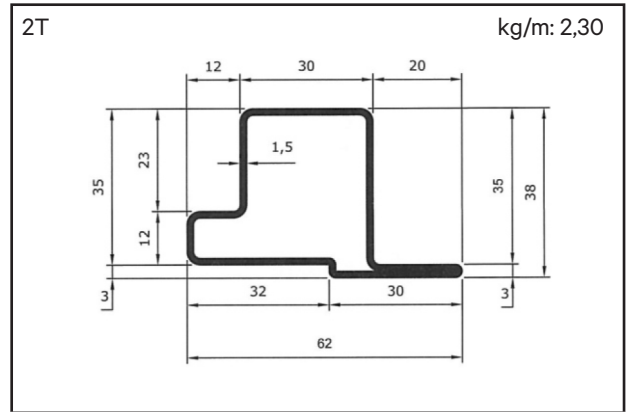
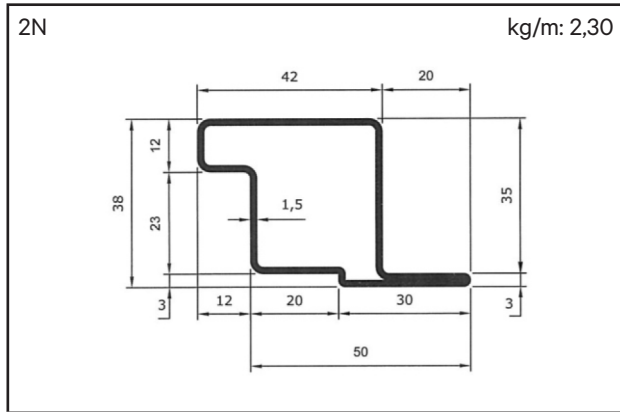
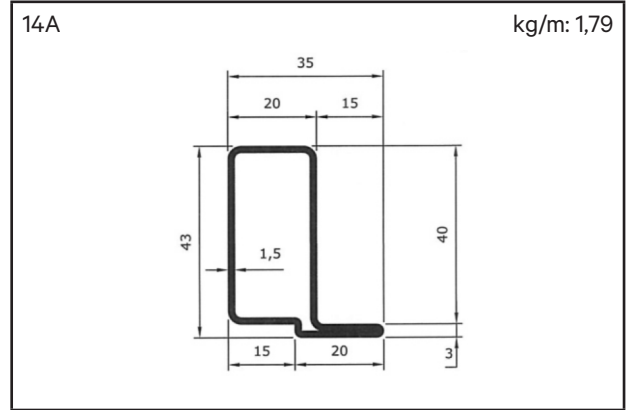
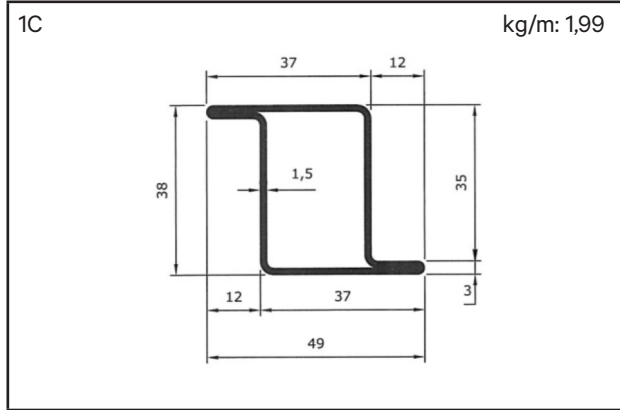

PROFILES FOR WINDOWS

2Z

kg/m: 1,88

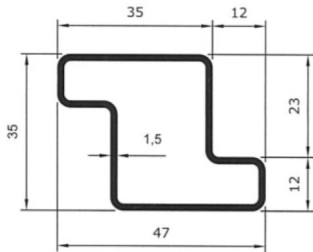
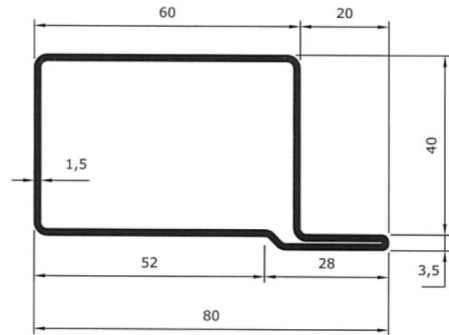

FIG. 1709

kg/m: 2,90



11A

kg/m: 1,70

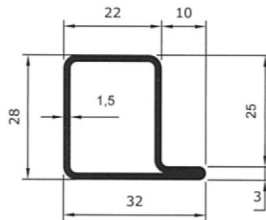

11B

kg/m: 2,11

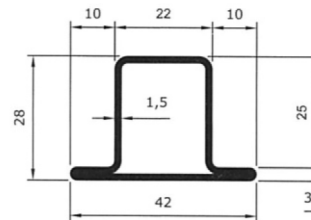

15A

kg/m: 2,04

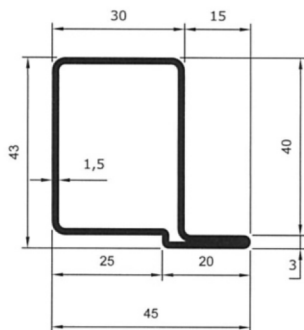

15Z

kg/m: 2,45

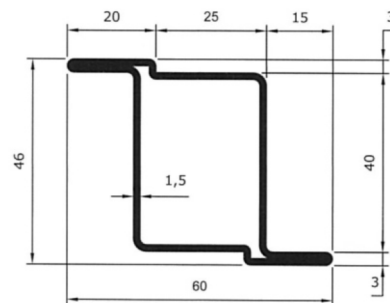

PROFILES FOR WINDOWS

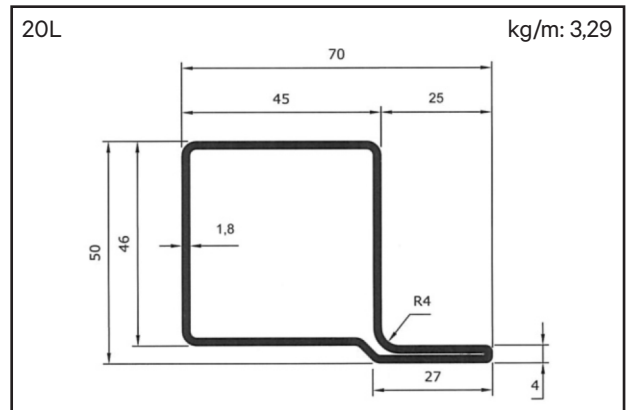
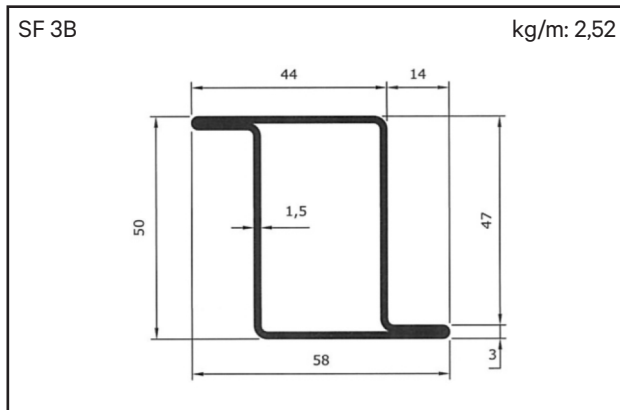
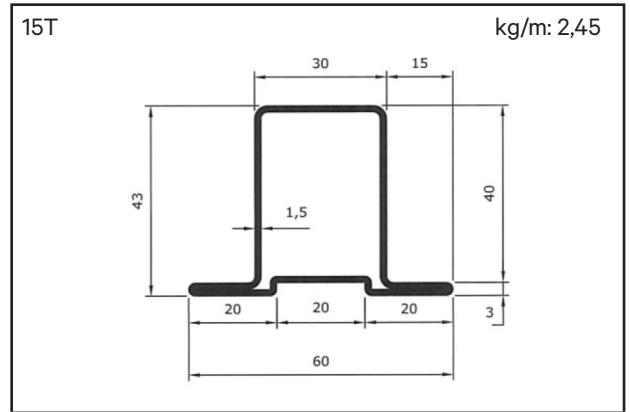
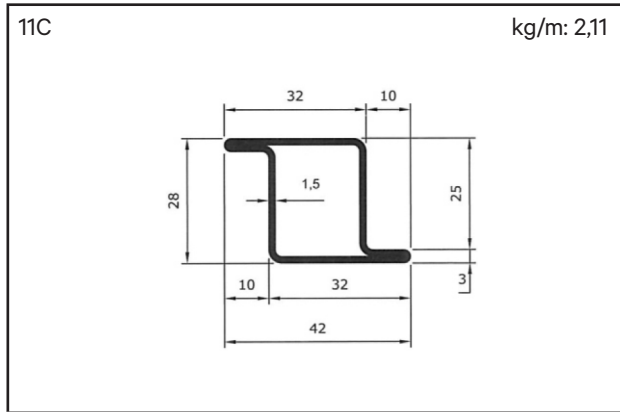
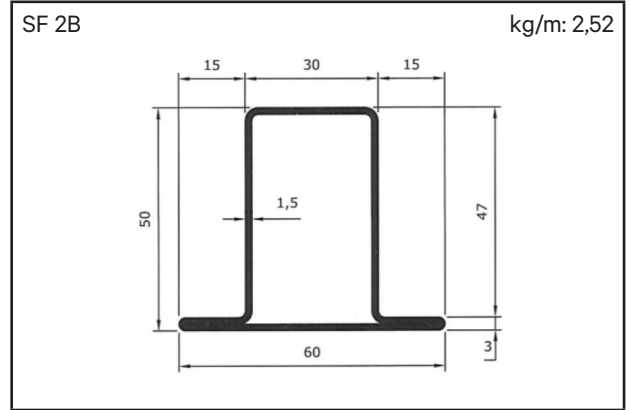
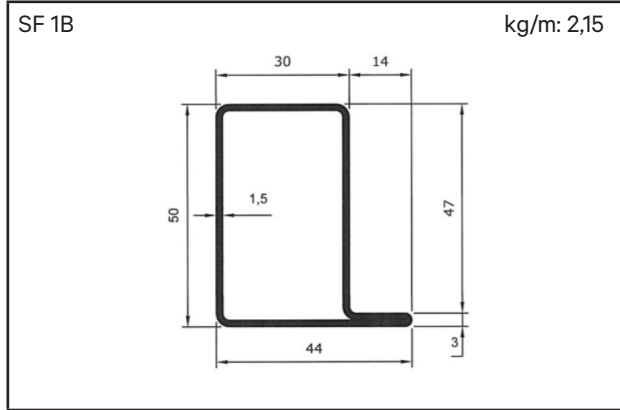

PROFILES FOR WINDOWS

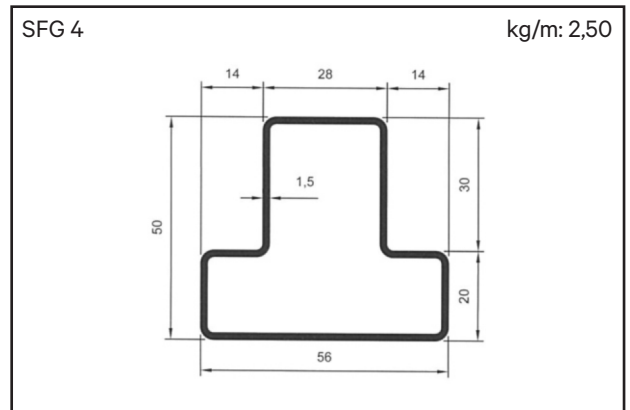
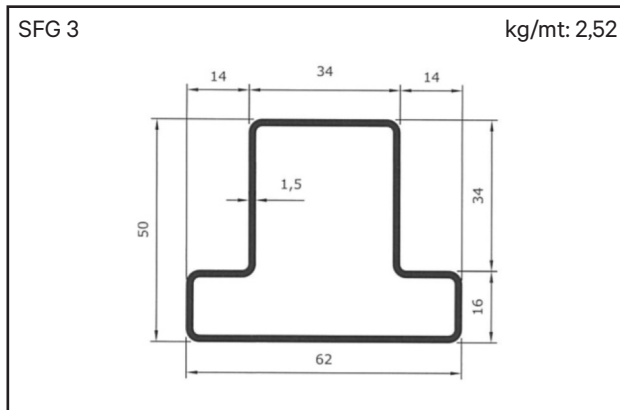
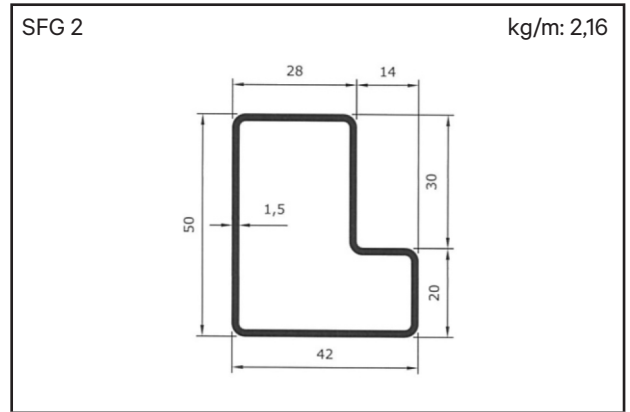
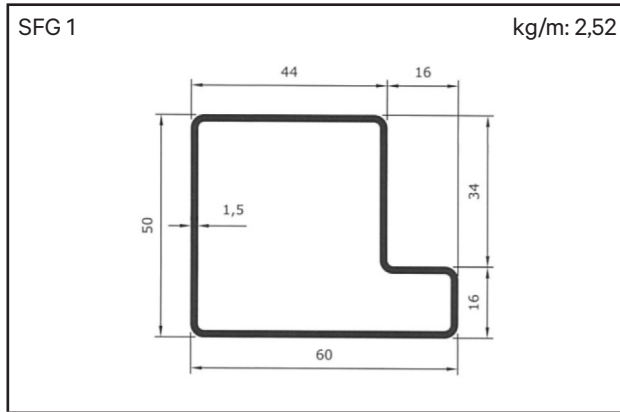
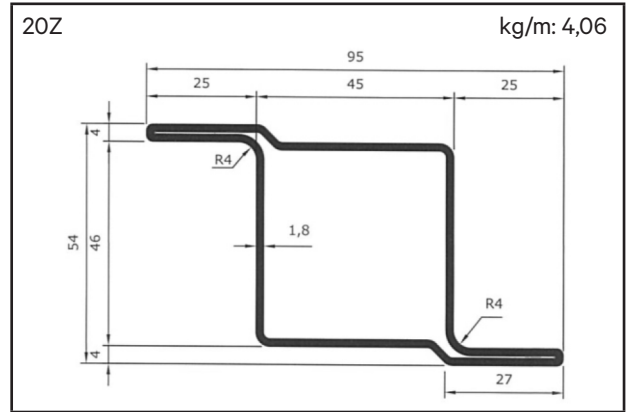
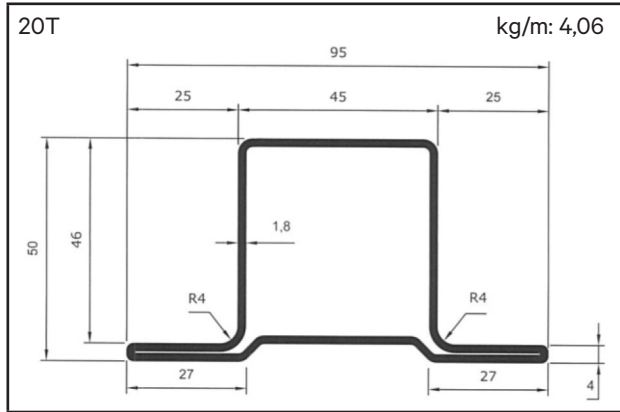

PROFILES FOR WINDOWS

